

### General Description

The AAT3237 MicroPower low dropout (LDO) linear regulator is ideally suited for portable applications where low noise, extended battery life, and small size are critical. The AAT3237 has been specifically designed for low output noise performance, fast transient response, and high power supply rejection ratio (PSRR).

Other features include low quiescent current, typically 70µA, and low dropout voltage, typically less than 400mV at full output current. The device is output short-circuit protected and has a thermal shutdown circuit for additional protection under extreme conditions.

The AAT3237 also features a low-power shutdown mode for extended battery life. A Power-OK open-drain output signals when  $V_{OUT}$  is in regulation.

The AAT3237 is available in a Pb-free, space-saving 6-pin SOT23 or 8-pin SC70JW package in 13 factory-programmed voltages: 1.2V, 1.5V, 1.8V, 2.0V, 2.3V, 2.5V, 2.7V, 2.8V, 2.85V, 2.9V, 3.0V, 3.3V, or 3.5V.

### Features

- Low Dropout: 400mV at 300mA
- Guaranteed 300mA Output
- High Accuracy  $\pm 1.5\%$
- 70µA Quiescent Current
- High Power Supply Ripple Rejection
- Power-OK (POK) Output
- Fast Line and Load Transient Response
- Short-Circuit Protection
- Over-Temperature Protection
- Uses Low Equivalent Series Resistance (ESR) Ceramic Capacitors
- Shutdown Mode for Longer Battery Life
- Low Temperature Coefficient
- 13 Factory-Programmed Output Voltages
- SOT23 6-Pin or SC70JW 8-Pin Package

### Applications

- Cellular Phones
- Desktop Computers
- Digital Cameras
- Notebook Computers
- Personal Portable Electronics
- Portable Communication Devices

### Typical Application

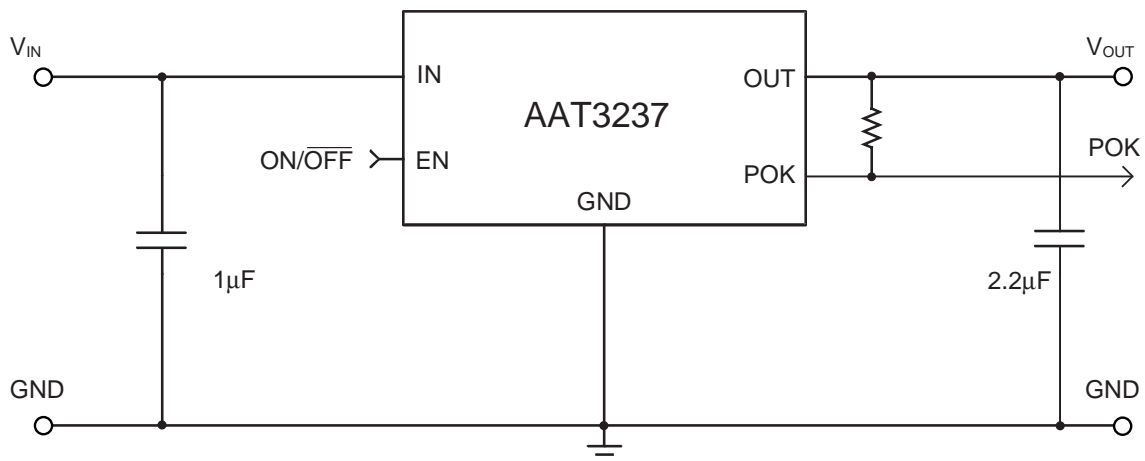

## Pin Descriptions

Pin #		Symbol	Function
SOT23-6	SC70JW-8		
1	5, 6	IN	Input voltage pin; should be decoupled with 1μF or greater capacitor.
2, 5	8	GND	Ground connection pin.
3	7	EN	Enable pin; this pin should not be left floating. When pulled low, the PMOS pass transistor turns off and all internal circuitry enters low-power mode, consuming less than 1μA.
4	1	POK	Power-OK output. This open-drain output is low when OUT is out of regulation. Connect a pull-up resistor from POK to OUT.
6	2, 3, 4	OUT	Output pin; should be decoupled with 2.2μF ceramic capacitor.

## Pin Configuration

**SOT23-6**  
(Top View)

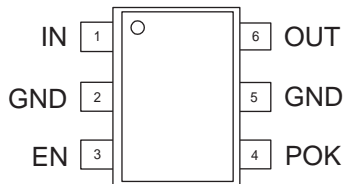

**SC70JW-8**  
(Top View)

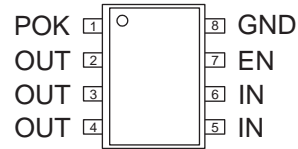

### Absolute Maximum Ratings<sup>1</sup>

$T_A = 25^\circ\text{C}$ , unless otherwise noted.

Symbol	Description	Value	Units
$V_{IN, POK}$	Input Voltage, POK	6	V
$V_{ENIN(MAX)}$	Maximum EN to Input Voltage	0.3	V
$I_{OUT}$	DC Output Current	$P_D / (V_{IN} - V_O)$	mA
$T_J$	Operating Junction Temperature Range	-40 to 150	$^\circ\text{C}$
$T_{LEAD}$	Maximum Soldering Temperature (at leads, 10 sec)	300	$^\circ\text{C}$

### Thermal Information<sup>2</sup>

Symbol	Description	Rating	Units
$\Theta_{JA}$	Maximum Thermal Resistance (SOT23-6, SC70JW-8)	150	$^\circ\text{C}/\text{W}$
$P_D$	Maximum Power Dissipation (SOT23-6, SC70JW-8)	667	mW

### Recommended Operating Conditions

Symbol	Description	Rating	Units
$V_{IN}$	Input Voltage <sup>3</sup>	$(V_{OUT} + V_{DO})$ to 5.5	V
T	Ambient Temperature Range	-40 to +85	$^\circ\text{C}$

1. Stresses above those listed in Absolute Maximum Ratings may cause permanent damage to the device. Functional operation at conditions other than the operating conditions specified is not implied. Only one Absolute Maximum Rating should be applied at any one time.
2. Mounted on a demo board.
3. To calculate minimum input voltage, use the following equation:  $V_{IN(MIN)} = V_{OUT(MAX)} + V_{DO(MAX)}$  as long as  $V_{IN} \geq 2.5\text{V}$ .

### Electrical Characteristics

$V_{IN} = V_{OUT(NOM)} + 1V$  for  $V_{OUT}$  options greater than 1.5V.  $V_{IN} = 2.5V$  for  $V_{OUT} \leq 1.5V$ .  $I_{OUT} = 1mA$ ,  $C_{OUT} = 2.2\mu F$ ,  $C_{IN} = 1\mu F$ ,  $T_A = -40^\circ C$  to  $+85^\circ C$ , unless otherwise noted. Typical values are  $T_A = 25^\circ C$ .

Symbol	Description	Conditions	Min	Typ	Max	Units	
$V_{OUT}$	Output Voltage Tolerance	$I_{OUT} = 1mA$ to $300mA$	$T_A = 25^\circ C$	-1.5		1.5	%
			$T_A = -40$ to $85^\circ C$	-2.5		2.5	
$I_{OUT}$	Output Current	$V_{OUT} > 1.2V$	300			mA	
$V_{DO}$	Dropout Voltage <sup>1,2</sup>	$I_{OUT} = 300mA$		400	600	mV	
$I_{SC}$	Short-Circuit Current	$V_{OUT} < 0.4V$		600		mA	
$I_Q$	Ground Current	$V_{IN} = 5V$ , No Load, $EN = V_{IN}$		70	125	$\mu A$	
$I_{SD}$	Shutdown Current	$V_{IN} = 5V$ , $EN = 0V$			1	$\mu A$	
$\frac{\Delta V_{OUT}}{V_{OUT} \cdot \Delta V_{IN}}$	Line Regulation <sup>3</sup>	$V_{IN} = V_{OUT} + 1$ to $5.0V$			0.09	%/V	
$\Delta V_{OUT}(\text{line})$	Dynamic Line Regulation	$V_{IN} = V_{OUT} + 1V$ to $V_{OUT} + 2V$ , $I_{OUT} = 300mA$ , $T_R/T_F = 2\mu s$		5		mV	
$\Delta V_{OUT}(\text{load})$	Dynamic Load Regulation	$I_{OUT} = 1mA$ to $300mA$ , $T_R < 5\mu s$		60		mV	
$V_{EN(L)}$	Enable Threshold Low				0.6	V	
$V_{EN(H)}$	Enable Threshold High		1.5			V	
$I_{EN}$	Leakage Current on Enable Pin	$V_{EN} = 5V$			1	$\mu A$	
$V_{POK}$	POK Trip Threshold	$V_{OUT}$ Rising, $T_A = 25^\circ C$	90	94	98	% of $V_{OUT}$	
$V_{POKHYS}$	POK Hysteresis			1		% of $V_{OUT}$	
$V_{POK(OL)}$	POK Output Voltage Low	$I_{SINK} = 1mA$			0.4	V	
$I_{POK}$	POK Output Leakage Current	$V_{POK} < 5.5V$ , $V_{OUT}$ in Regulation			1	$\mu A$	
PSRR	Power Supply Rejection Ratio	$I_{OUT} = 10mA$	1kHz		65	dB	
			10kHz		45		
			1MHz		42		
$T_{SD}$	Over-Temperature Shutdown Threshold			145		$^\circ C$	
$T_{HYS}$	Over-Temperature Shutdown Hysteresis			12		$^\circ C$	
$e_N$	Output Noise			250		$\mu V_{rms}$	
TC	Output Voltage Temperature Coefficient			22		ppm/ $^\circ C$	

1.  $V_{DO}$  is defined as  $V_{IN} - V_{OUT}$  when  $V_{OUT}$  is 98% of nominal.

2. For  $V_{OUT} < 2.1V$ ,  $V_{DO} = 2.5V - V_{OUT}$ .

3.  $C_{IN} = 10\mu F$ .

## Typical Characteristics

Unless otherwise noted,  $V_{IN} = 5V$ ,  $T_A = 25^\circ C$ .

### Dropout Voltage vs. Temperature

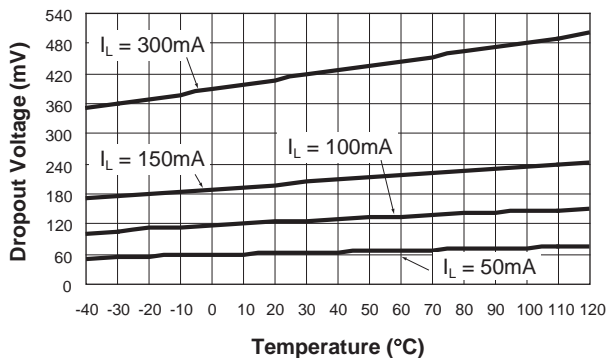

### Dropout Characteristics

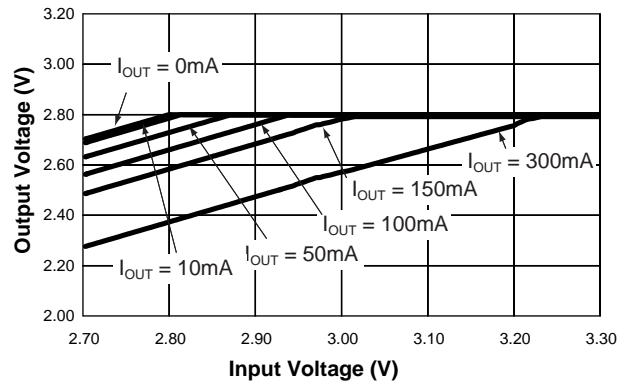

### Dropout Voltage vs. Output Current

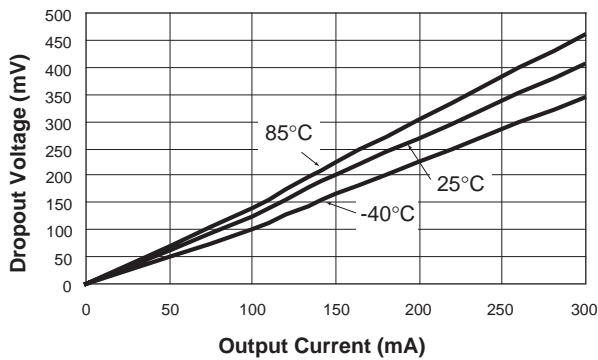

### Ground Current vs. Input Voltage

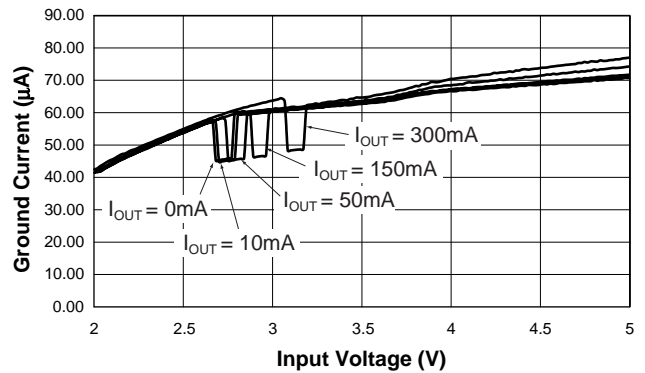

### Quiescent Current vs. Temperature

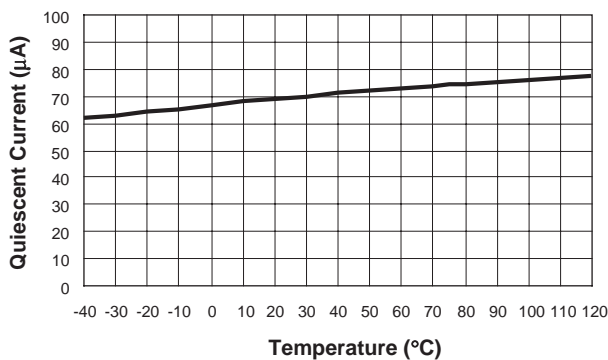

### Output Voltage vs. Temperature

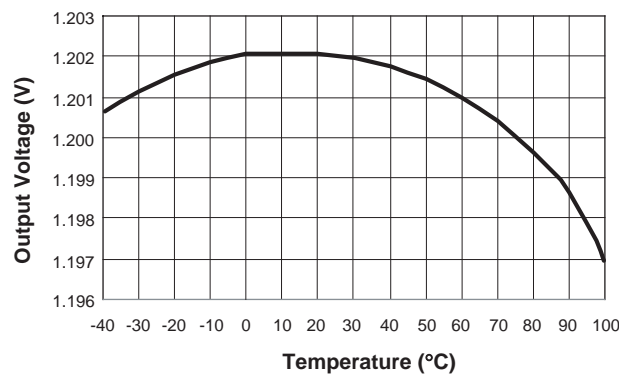

### Typical Characteristics

Unless otherwise noted,  $V_{IN} = 5V$ ,  $T_A = 25^\circ C$ .

**Turn-On Time and POK Delay**

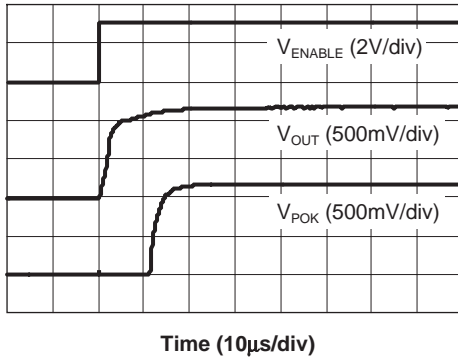

**Turn-Off Time with POK Delay**

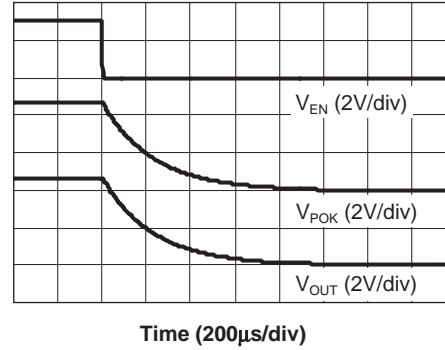

**Line Transient Response**

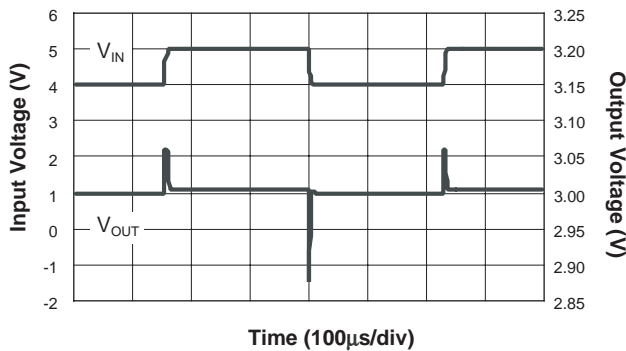

**POK Output Response**

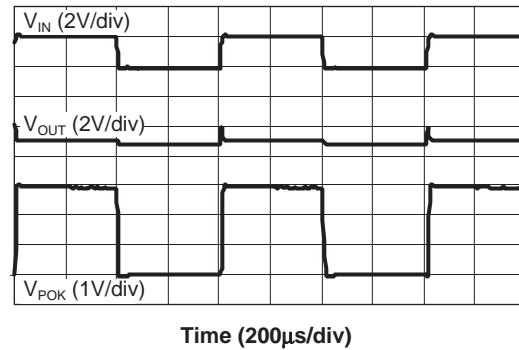

**Load Transient Response**

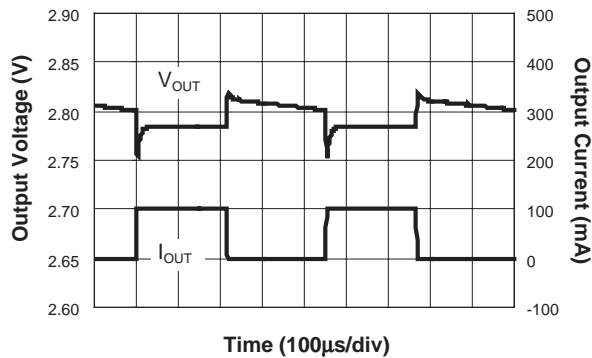

**Load Transient Response 300mA**

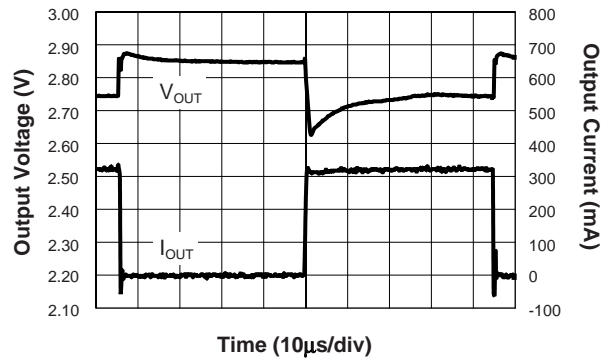

### Typical Characteristics

Unless otherwise noted,  $V_{IN} = 5V$ ,  $T_A = 25^\circ C$ .

**Over-Current Protection**

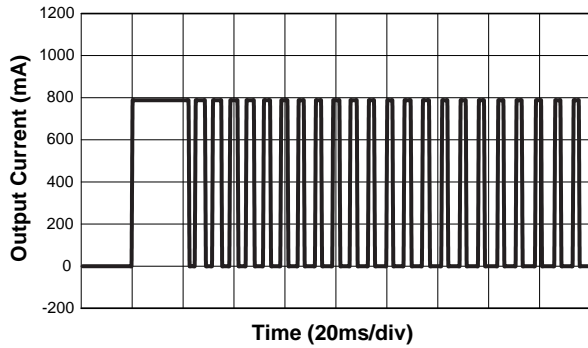

**AAT3237 Self Noise**

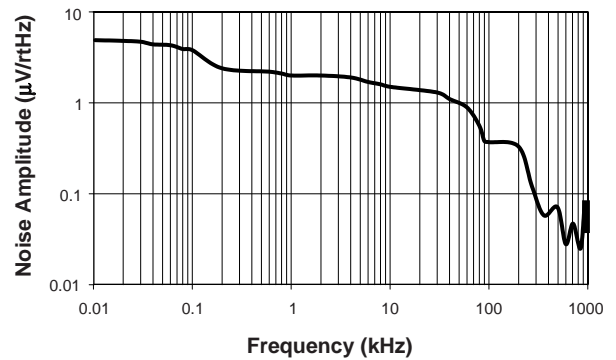

**$V_{EN(H)}$  and  $V_{EN(L)}$  vs.  $V_{IN}$**

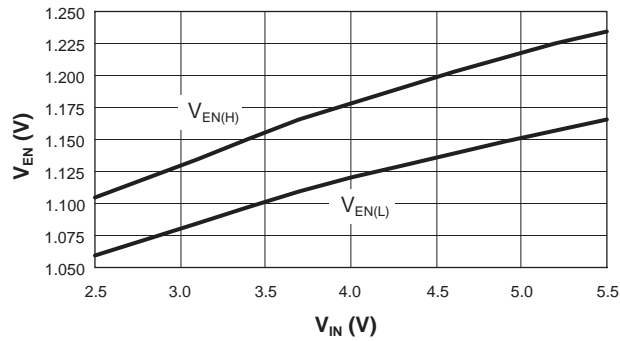

## Functional Block Diagram

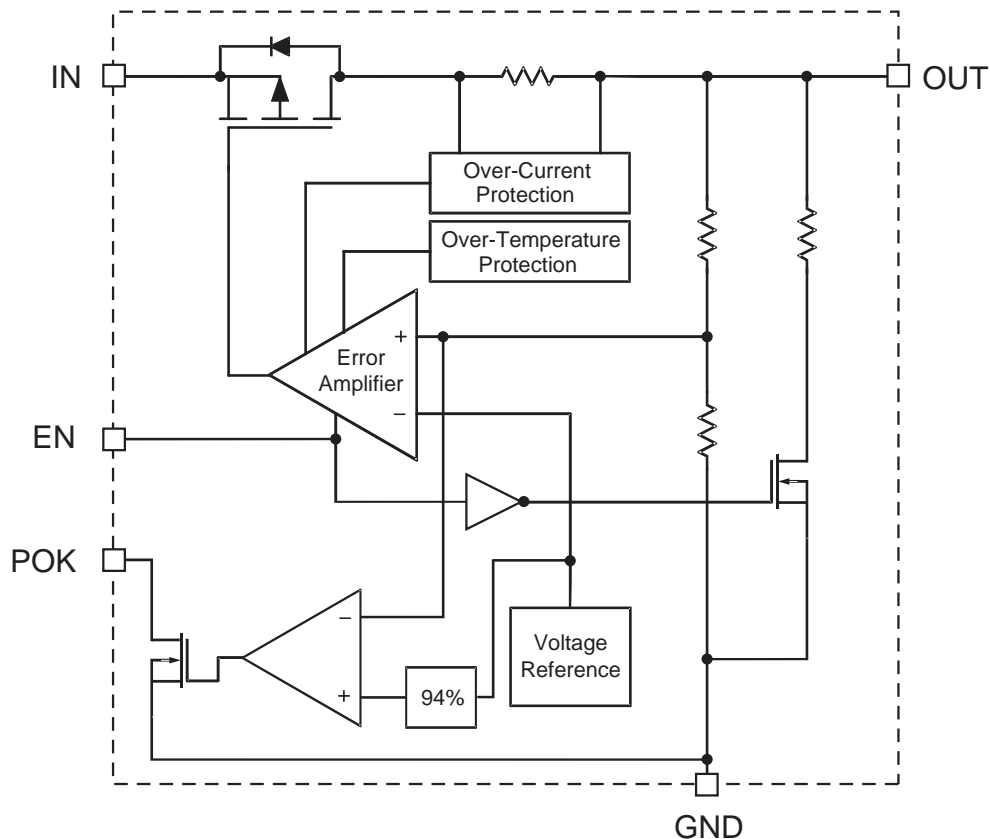

## Functional Description

The AAT3237 is intended for LDO regulator applications where output current load requirements range from no load to 300mA.

The advanced circuit design of the AAT3237 provides excellent transient response and fast turn-on ability. The LDO regulator output has been specifically optimized to function with low-cost, low-ESR ceramic capacitors. However, the design will allow for operation over a wide range of capacitor types.

The AAT3237 has an integrated Power-OK comparator which indicates when the output is out of regulation.

The device enable circuit is provided to shut down the LDO regulator for power conservation in portable products. The enable circuit has an additional output capacitor discharge circuit to assure sharp application circuit turn-off upon device shutdown.

This LDO regulator has complete short-circuit and thermal protection. The integral combination of these two internal protection circuits gives the AAT3237 a comprehensive safety system during extreme adverse operating conditions. Device power dissipation is limited to the package type and thermal dissipation properties. Refer to the Thermal Considerations section of this datasheet for details on device operation at maximum output current loads.



## Applications Information

To assure the maximum possible performance is obtained from the AAT3237, please refer to the following application recommendations.

### Input Capacitor

Typically, a 1 $\mu$ F or larger capacitor is recommended for  $C_{IN}$  in most applications. A  $C_{IN}$  capacitor is not required for basic LDO regulator operation. However, if the AAT3237 is physically located more than three centimeters from an input power source, a  $C_{IN}$  capacitor will be needed for stable operation.  $C_{IN}$  should be located as closely to the device  $V_{IN}$  pin as practically possible.  $C_{IN}$  values greater than 1 $\mu$ F will offer superior input line transient response and will assist in maximizing the highest possible power supply ripple rejection.

Ceramic, tantalum, or aluminum electrolytic capacitors may be selected for  $C_{IN}$ . There is no specific capacitor ESR requirement for  $C_{IN}$ . However, for 300mA LDO regulator output operation, ceramic capacitors are recommended for  $C_{IN}$  due to their inherent capability over tantalum capacitors to withstand input current surges from low impedance sources such as batteries in portable devices.

### Output Capacitor

For proper load voltage regulation and operational stability, a capacitor is required between pins  $V_{OUT}$  and GND. The  $C_{OUT}$  capacitor connection to the LDO regulator ground pin should be made as direct as practically possible for maximum device performance.

The AAT3237 has been specifically designed to function with very low ESR ceramic capacitors. For best performance, ceramic capacitors are recommended.

Typical output capacitor values for maximum output current conditions range from 1 $\mu$ F to 10 $\mu$ F. Applications utilizing the exceptionally low output noise and optimum power supply ripple rejection characteristics of the AAT3237 should use 2.2 $\mu$ F or greater for  $C_{OUT}$ . If desired,  $C_{OUT}$  may be increased without limit.

In low output current applications where output load is less than 10mA, the minimum value for  $C_{OUT}$  can be as low as 0.47 $\mu$ F.

## Capacitor Characteristics

Ceramic composition capacitors are highly recommended over all other types of capacitors for use with the AAT3237. Ceramic capacitors offer many advantages over their tantalum and aluminum electrolytic counterparts. A ceramic capacitor typically has very low ESR, is lower cost, has a smaller PCB footprint, and is non-polarized. Line and load transient response of the LDO regulator is improved by using low ESR ceramic capacitors. Since ceramic capacitors are non-polarized, they are not prone to incorrect connection damage.

**Equivalent Series Resistance:** ESR is a very important characteristic to consider when selecting a capacitor. ESR is the internal series resistance associated with a capacitor that includes lead resistance, internal connections, size and area, material composition, and ambient temperature. Typically, capacitor ESR is measured in milliohms for ceramic capacitors and can range to more than several ohms for tantalum or aluminum electrolytic capacitors.

**Ceramic Capacitor Materials:** Ceramic capacitors less than 0.1 $\mu$ F are typically made from NPO or C0G materials. NPO and C0G materials generally have tight tolerance and are very stable over temperature. Larger capacitor values are usually composed of X7R, X5R, Z5U, or Y5V dielectric materials. These two material types are not recommended for use with LDO regulators since the capacitor tolerance can vary more than  $\pm 50\%$  over the operating temperature range of the device. A 2.2 $\mu$ F Y5V capacitor could be reduced to 1 $\mu$ F over temperature; this could cause problems for circuit operation. X7R and X5R dielectrics are much more desirable. The temperature tolerance of X7R dielectric is better than  $\pm 15\%$ .

Capacitor area is another contributor to ESR. Capacitors that are physically large in size will have a lower ESR when compared to a smaller sized capacitor of an equivalent material and capacitance value. These larger devices can improve circuit transient response when compared to an equal value capacitor in a smaller package size.

Consult capacitor vendor datasheets carefully when selecting capacitors for LDO regulators.

## POK Output

The AAT3237 features an integrated Power-OK comparator which can be used as an error flag. The POK open-drain output goes low when OUT is 6% below its nominal regulation voltage. Connect a pull-up resistor from POK to OUT.

## Enable Function

The AAT3237 features an LDO regulator enable/disable function. This pin (EN) is active high and is compatible with CMOS logic. To assure the LDO regulator will switch on, the EN turn-on control level must be greater than 2.0V. The LDO regulator will go into the disable shutdown mode when the voltage on the EN pin falls below 0.6V. If the enable function is not needed in a specific application, it may be tied to  $V_{IN}$  to keep the LDO regulator in a continuously on state.

When the LDO regulator is in shutdown mode, an internal 1.5k $\Omega$  resistor is connected between  $V_{OUT}$  and GND. This is intended to discharge  $C_{OUT}$  when the LDO regulator is disabled. The internal 1.5k $\Omega$  has no adverse effect on device turn-on time.

## Short-Circuit Protection

The AAT3237 contains an internal short-circuit protection circuit that will trigger when the output load current exceeds the internal threshold limit. Under short-circuit conditions, the output of the LDO regulator will be current limited until the short-circuit condition is removed from the output or LDO regulator package power dissipation exceeds the device thermal limit.

## Thermal Protection

The AAT3237 has an internal thermal protection circuit which will turn on when the device die temperature exceeds 145°C. The internal thermal protection circuit will actively turn off the LDO regulator output

pass device to prevent the possibility of over-temperature damage. The LDO regulator output will remain in a shutdown state until the internal die temperature falls back below the 145°C trip point.

The combination and interaction between the short-circuit and thermal protection systems allows the LDO regulator to withstand indefinite short-circuit conditions without sustaining permanent damage.

## No-Load Stability

The AAT3237 is designed to maintain output voltage regulation and stability under operational no-load conditions. This is an important characteristic for applications where the output current may drop to zero.

## Reverse Output-to-Input Voltage Conditions and Protection

Under normal operating conditions, a parasitic diode exists between the output and input of the LDO regulator. The input voltage should always remain greater than the output load voltage, maintaining a reverse bias on the internal parasitic diode. Conditions where  $V_{OUT}$  might exceed  $V_{IN}$  should be avoided since this would forward bias the internal parasitic diode and allow excessive current flow into the  $V_{OUT}$  pin, possibly damaging the LDO regulator.

In applications where there is a possibility of  $V_{OUT}$  exceeding  $V_{IN}$  for brief amounts of time during normal operation, the use of a larger value  $C_{IN}$  capacitor is highly recommended. A larger value of  $C_{IN}$  with respect to  $C_{OUT}$  will effect a slower  $C_{IN}$  decay rate during shutdown, thus preventing  $V_{OUT}$  from exceeding  $V_{IN}$ . In applications where there is a greater danger of  $V_{OUT}$  exceeding  $V_{IN}$  for extended periods of time, it is recommended to place a Schottky diode across  $V_{IN}$  to  $V_{OUT}$  (connecting the cathode to  $V_{IN}$  and anode to  $V_{OUT}$ ). The Schottky diode forward voltage should be less than 0.45V.

## Ordering Information

Output Voltage	Package	Marking <sup>1</sup>	Part Number (Tape and Reel) <sup>2</sup>
1.2V	SOT23-6		AAT3237IGU-1.2-T1
1.5V	SOT23-6		AAT3237IGU-1.5-T1
1.8V	SOT23-6		AAT3237IGU-1.8-T1
2.0V	SOT23-6		AAT3237IGU-2.0-T1
2.3V	SOT23-6		AAT3237IGU-2.3-T1
2.5V	SOT23-6		AAT3237IGU-2.5-T1
2.7V	SOT23-6		AAT3237IGU-2.7-T1
2.8V	SOT23-6	FBXYY	<b>AAT3237IGU-2.8-T1</b>
2.85V	SOT23-6	GRXYY	<b>AAT3237IGU-2.85-T1</b>
2.9V	SOT23-6	GSXYY	<b>AAT3237IGU-2.9-T1</b>
3.0V	SOT23-6	GMXYY	<b>AAT3237IGU-3.0-T1</b>
3.3V	SOT23-6	HRXYY	<b>AAT3237IGU-3.3-T1</b>
3.5V	SOT23-6		AAT3237IGU-3.5-T1
1.2V	SC70JW-8		AAT3237IJS-1.2-T1
1.5V	SC70JW-8		AAT3237IJS-1.5-T1
1.8V	SC70JW-8		AAT3237IJS-1.8-T1
2.0V	SC70JW-8		AAT3237IJS-2.0-T1
2.3V	SC70JW-8		AAT3237IJS-2.3-T1
2.5V	SC70JW-8		AAT3237IJS-2.5-T1
2.7V	SC70JW-8		AAT3237IJS-2.7-T1
2.8V	SC70JW-8		AAT3237IJS-2.8-T1
2.85V	SC70JW-8		AAT3237IJS-2.85-T1
2.9V	SC70JW-8		AAT3237IJS-2.9-T1
3.0V	SC70JW-8		AAT3237IJS-3.0-T1
3.3V	SC70JW-8		AAT3237IJS-3.3-T1
3.5V	SC70JW-8		AAT3237IJS-3.5-T1



All AnalogicTech products are offered in Pb-free packaging. The term “Pb-free” means semiconductor products that are in compliance with current RoHS standards, including the requirement that lead not exceed 0.1% by weight in homogeneous materials. For more information, please visit our website at <http://www.analogictech.com/pbfree>.

1. XYY = assembly and date code.

2. Sample stock is generally held on all part numbers listed in **BOLD**.

## Package Information

### SOT23-6

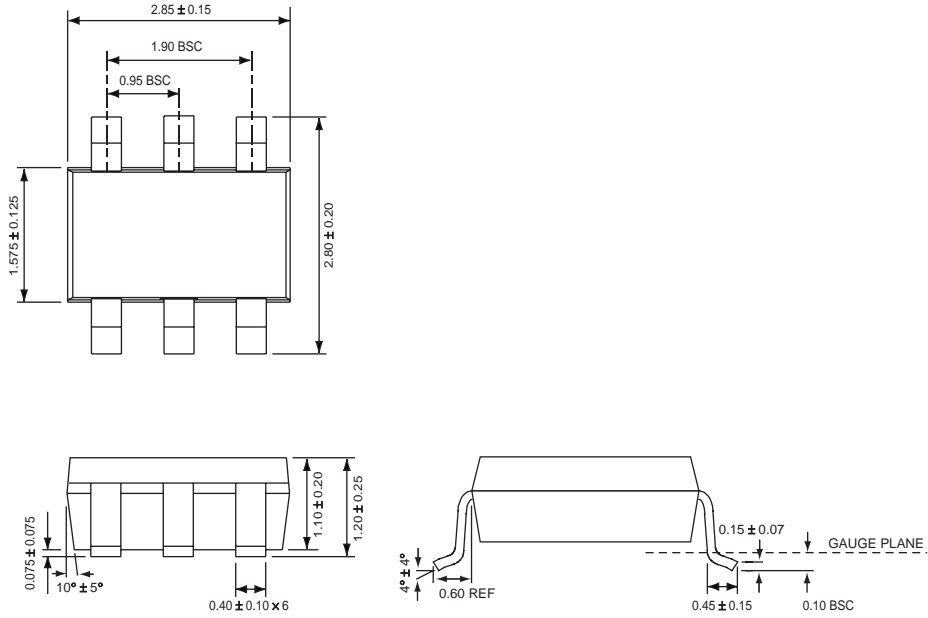

All dimensions in millimeters.

### SC70JW-8

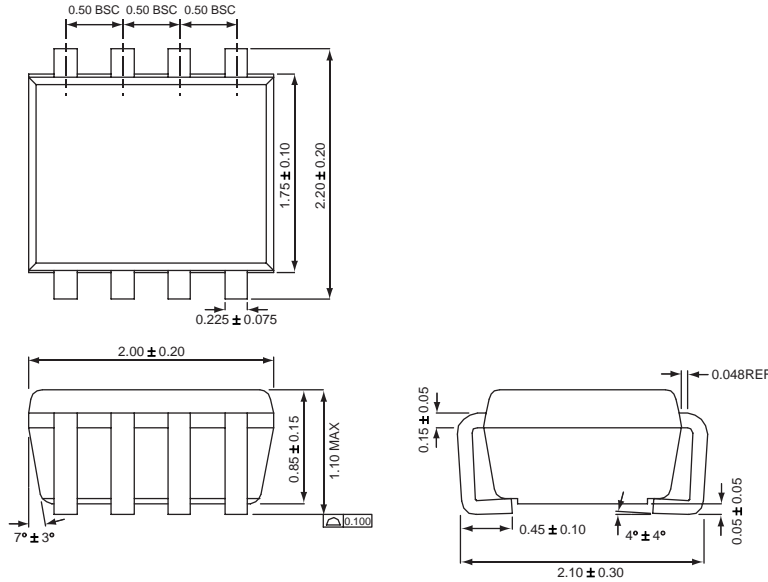

All dimensions in millimeters.

© Advanced Analogic Technologies, Inc.

AnalogicTech cannot assume responsibility for use of any circuitry other than circuitry entirely embodied in an AnalogicTech product. No circuit patent licenses, copyrights, mask work rights, or other intellectual property rights are implied. AnalogicTech reserves the right to make changes to their products or specifications or to discontinue any product or service without notice. Customers are advised to obtain the latest version of relevant information to verify, before placing orders, that information being relied on is current and complete. All products are sold subject to the terms and conditions of sale supplied at the time of order acknowledgement, including those pertaining to warranty, patent infringement, and limitation of liability. AnalogicTech warrants performance of its semiconductor products to the specifications applicable at the time of sale in accordance with AnalogicTech's standard warranty. Testing and other quality control techniques are utilized to the extent AnalogicTech deems necessary to support this warranty. Specific testing of all parameters of each device is not necessarily performed.

**Advanced Analogic Technologies, Inc.**  
 830 E. Arques Avenue, Sunnyvale, CA 94085  
 Phone (408) 737-4600  
 Fax (408) 737-4611